

# P<sup>2</sup>

## PLAZA DE LA MERCED A PLAY-SCAPE

A PROJECT TAUGHT TO RESPOND TO THE ACTIVITIES DEVELOPED IN THE PLAZA THROUGHOUT THE YEAR. THE MIST GIVES A SENSE OF REFRESHING DURING DAYTIME AND JOINED WITH THE PLAZA IT TURNS INTO A PLAYGROUND THAT INVITES CHILDREN TO SPEND TIME. THE SLOPE ALLOWS THE USER TO GO TO THE UPPER LEVEL OF THE WALL THAT BECOMES A STAGE GIVING A DIFFERENT PERSPECTIVE OF THE GROUND LEVEL. THE LANDSCAPE AN URBANISM REACTS ON A MUCH MORE RESPECTFUL AND DIGNIFIED CITY LIFE FOR PEOPLE TO ENJOY CARTAGENA.

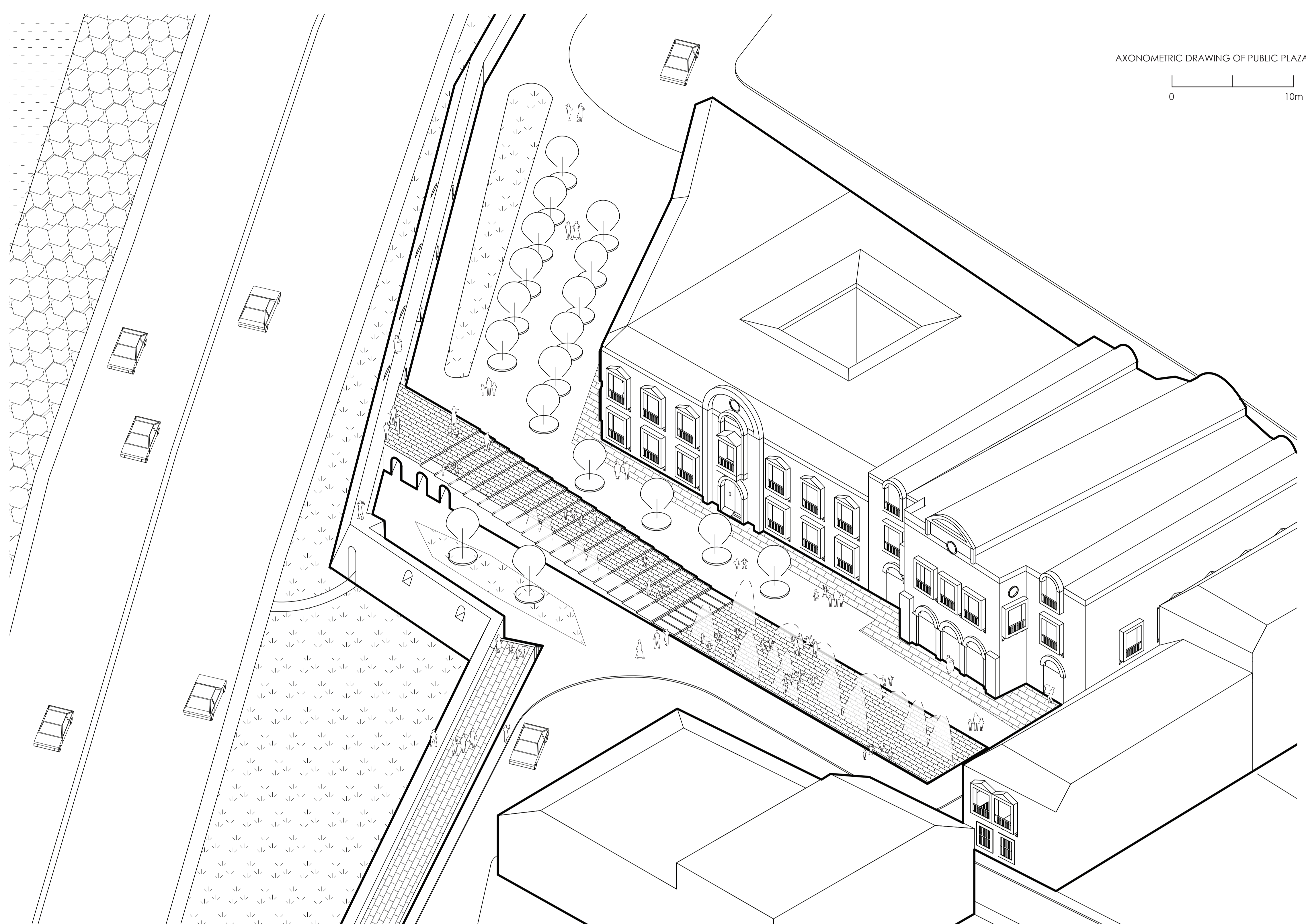

AXONOMETRIC DRAWING OF PUBLIC PLAZA  
 0 10m

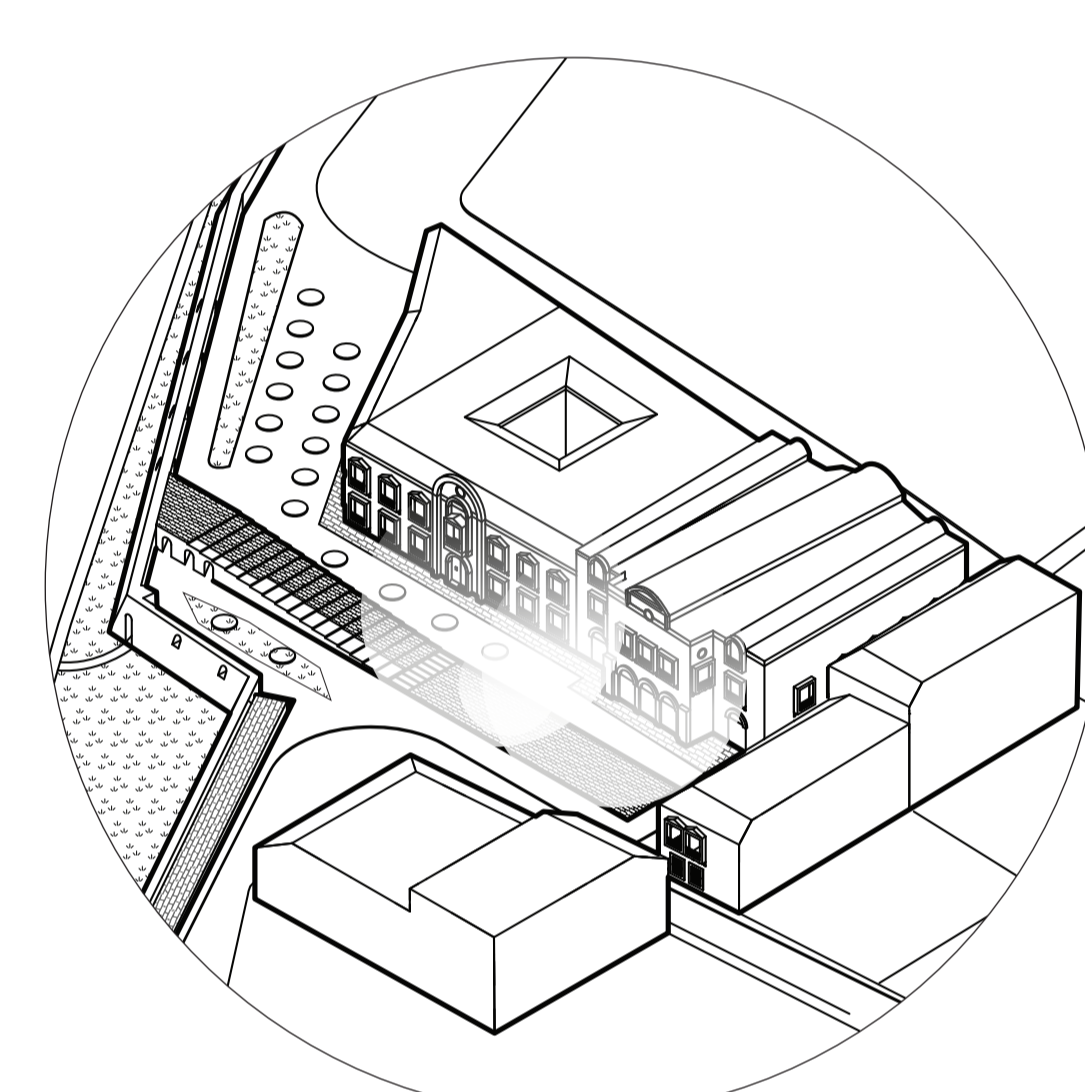

BLURRING ARCHITECTURE  
 FOGGING SPACE WITH MIST

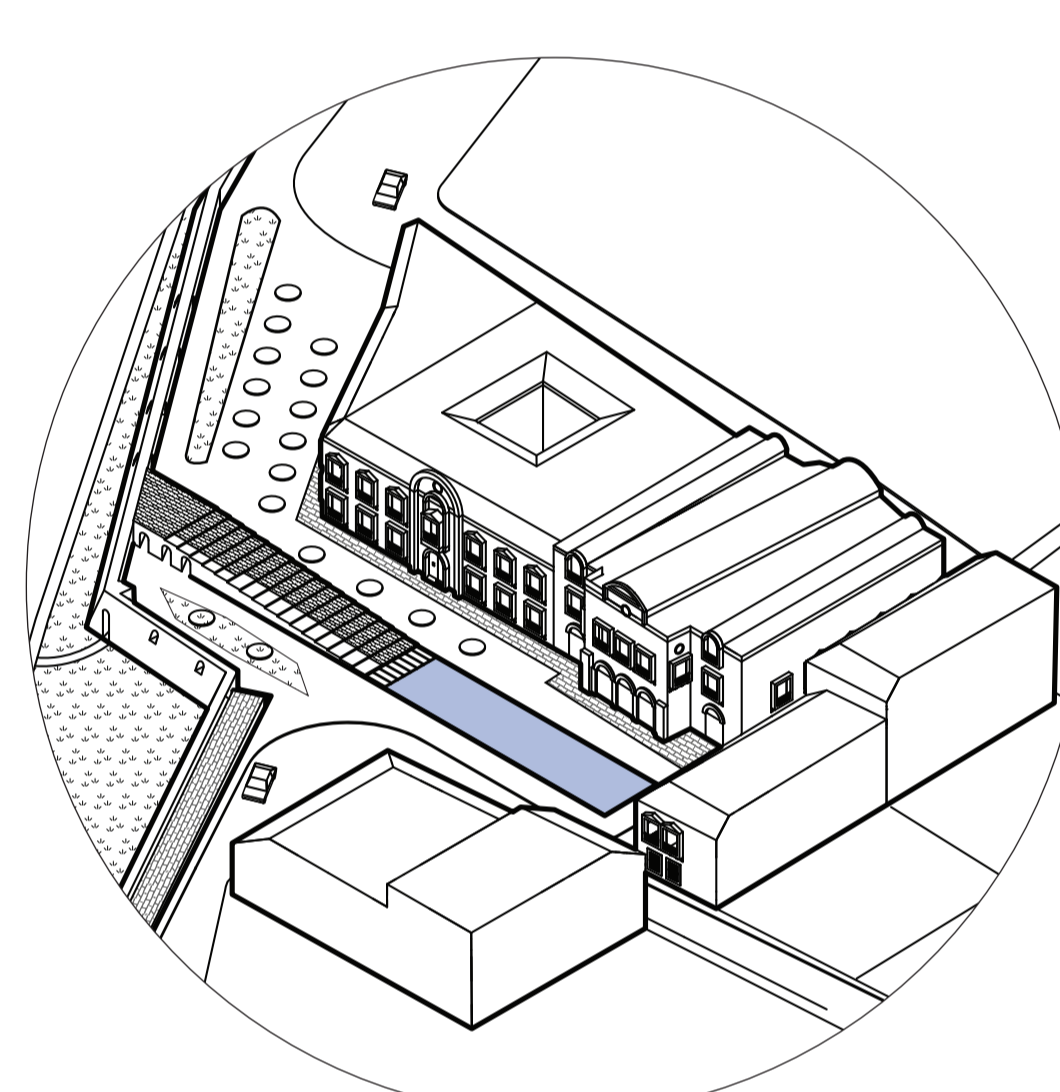

WATER PLAYScape MIRRORING  
 HERITAGE BUILDING

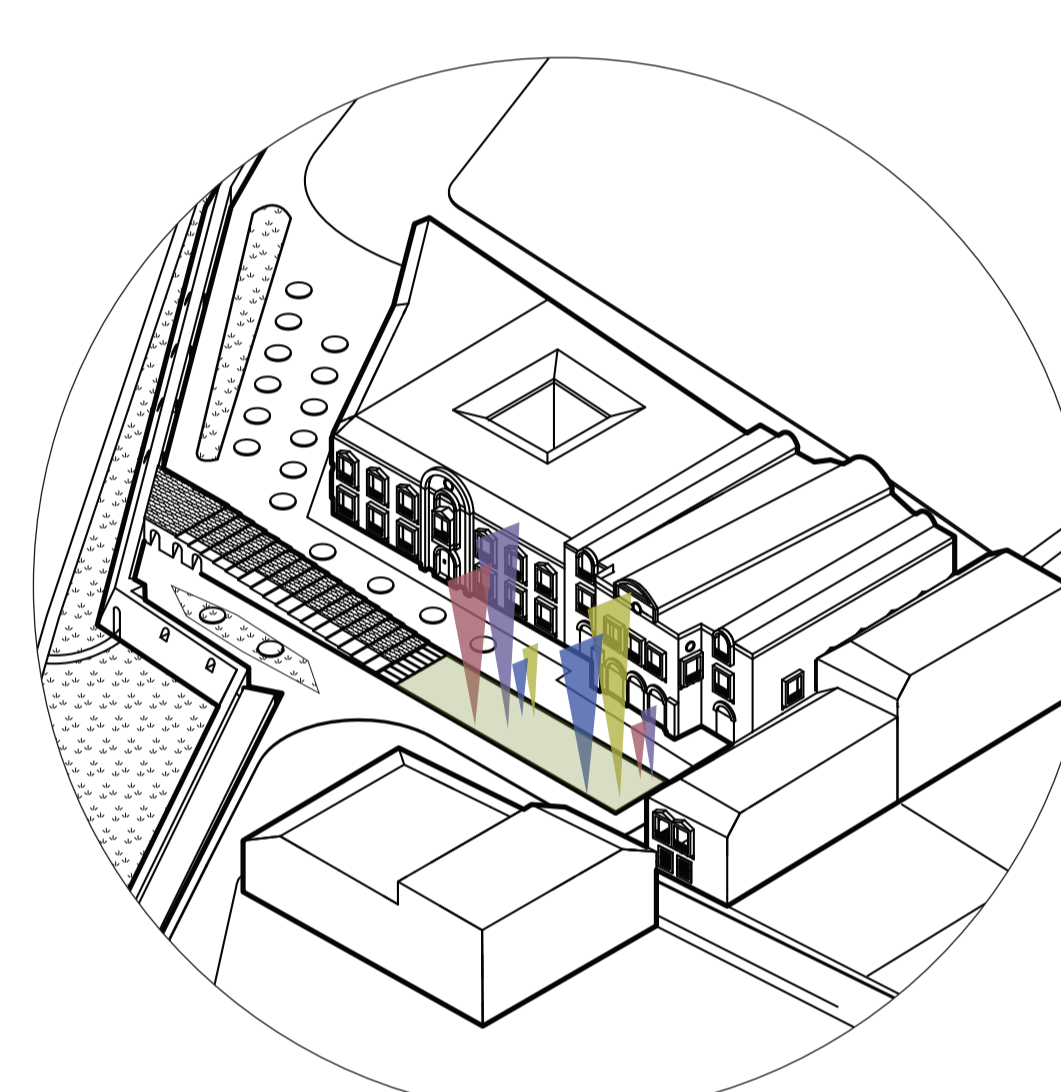

A PERFORMATIVE STAGE FOR  
 PUBLIC FESTIVAL AND EVENTS

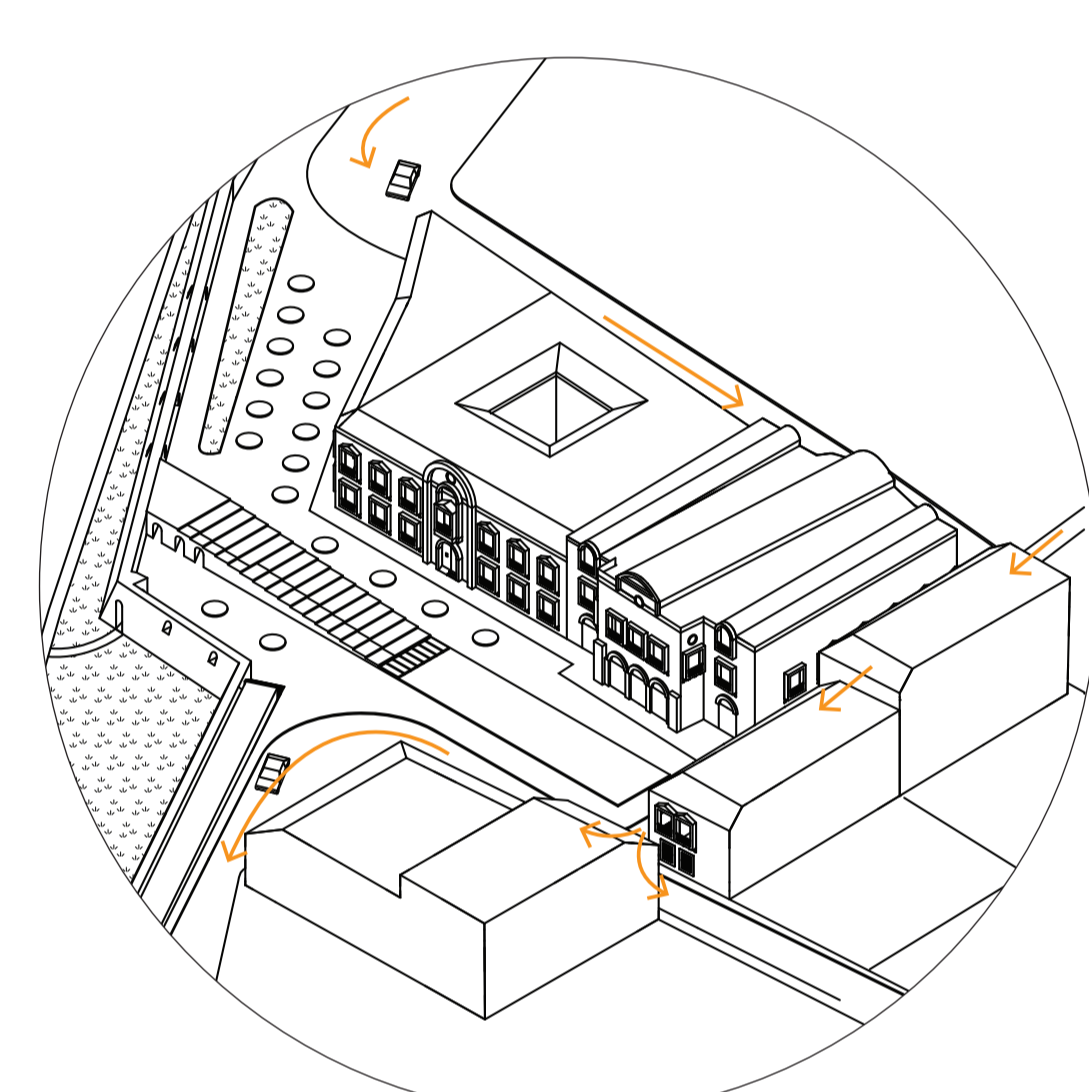

ENLARGE PARK AND  
 DIVERTED DRIVEWAY

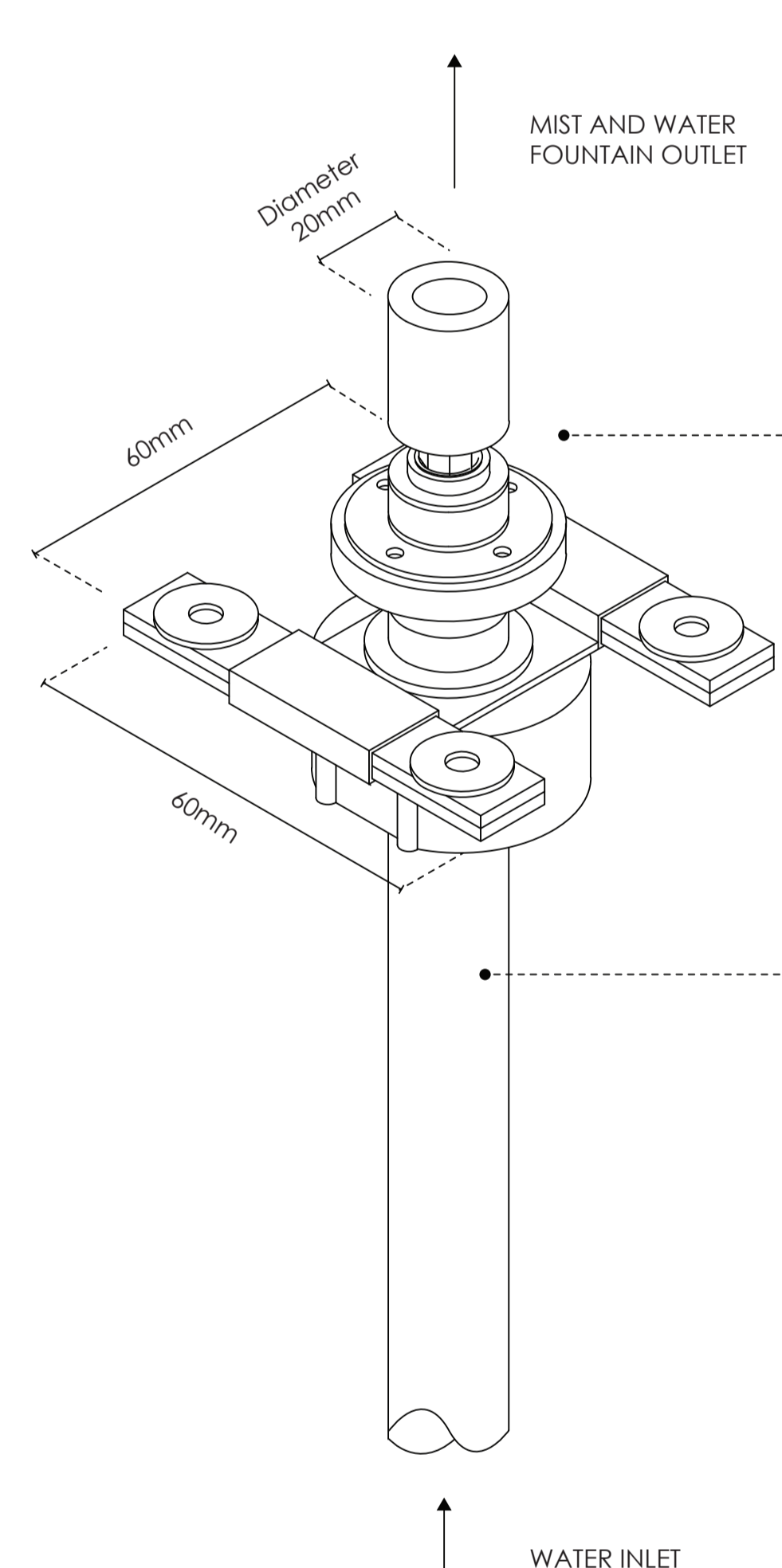

WATER FOUNTAIN SPRINKLER  
 2 IN 1 MIST & WATER SPRINKLER  
 TO MANUFACTURER'S DETAIL  
 0 50mm  
 SCALE 1:1

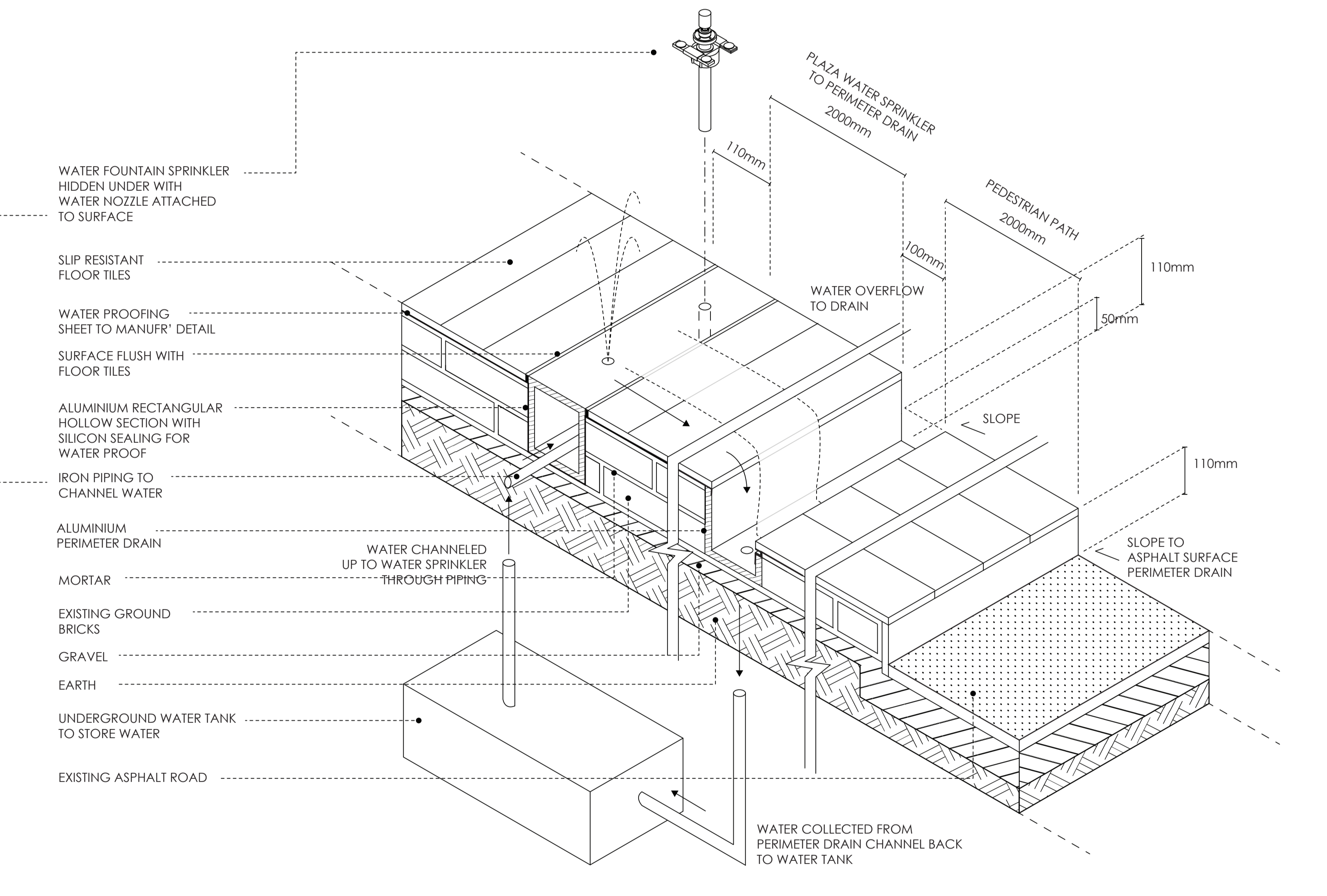

WATER FOUNTAIN PLAZA, PEDESTRIAN PAVEMENT  
 AND ASPHALT ROAD CONNECTION DETAILS  
 0 200mm  
 SCALE 1:5



PLAZA SECTION  
 0 10m  
 SCALE 1:250

REFER TO DETAIL

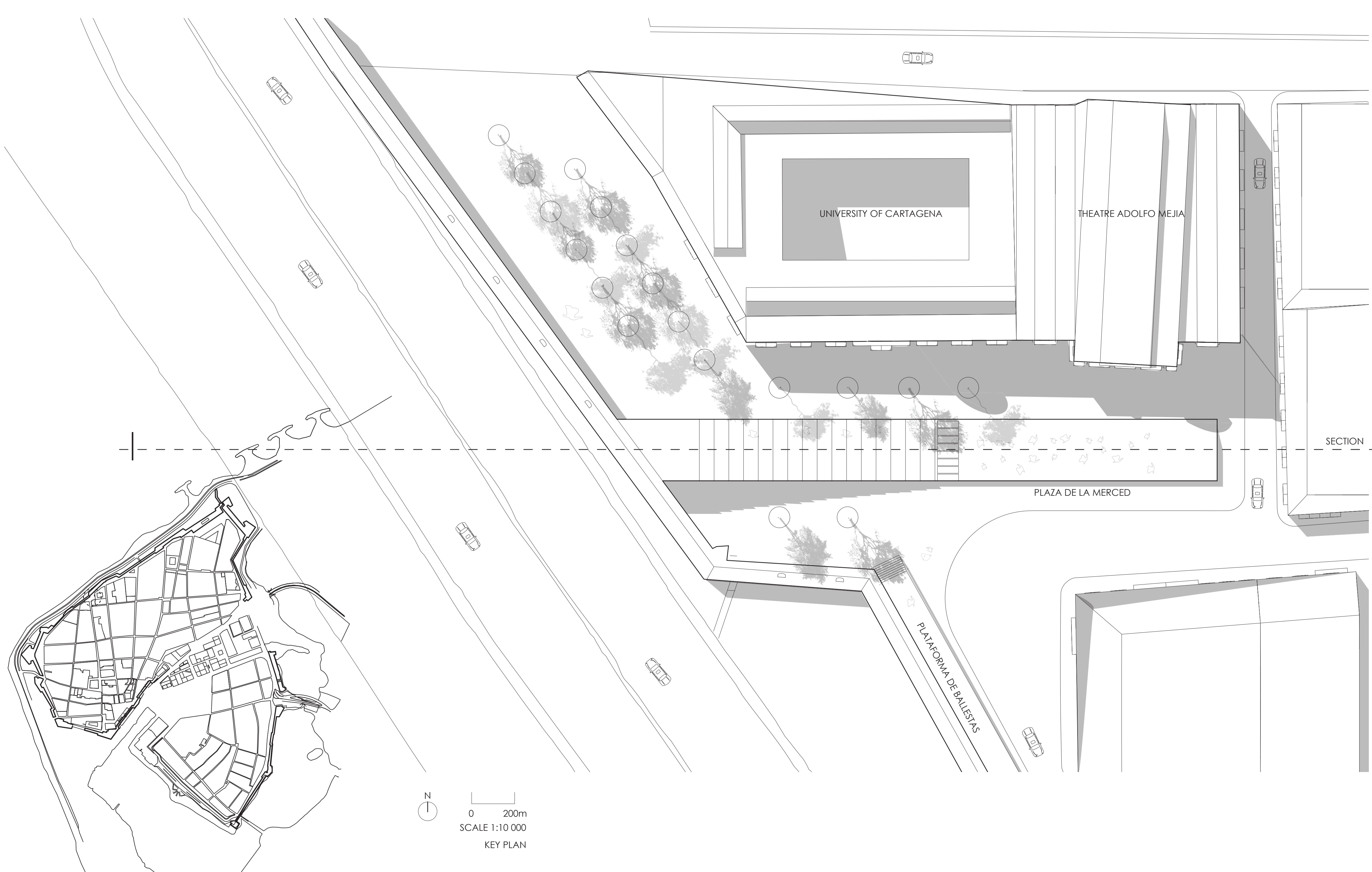

0 200m  
 SCALE 1:10 000  
 KEY PLAN